

## POWERWALL-X VERTICAL LED WALLPACK

### INSTALLATION, USAGE, & CARE GUIDE

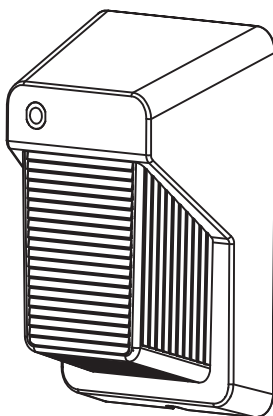

#### **Questions? / Missing Parts? / Need Accessories?**

Before returning to the store, call or email our  
Lighting Specialists 9am-5pm EST Monday to Friday.

**1-844-507-5651**

support@probrite.com

www.probrite.com

---

Visit us online anytime or call us to get information on our product range, download detailed spec & photometric files, find product and mounting accessories, view installation tutorials and videos, and learn about our DLC® rebate eligible products.

# TABLE OF CONTENTS

<b>Table of Contents</b> .....	<b>2</b>	<b>Hardware Included</b> .....	<b>4</b>
<b>Safety Information</b> .....	<b>2</b>	<b>Installation</b> .....	<b>5</b>
<b>Pre-Installation</b> .....	<b>3</b>	<b>Operation</b> .....	<b>9</b>
Planning Installation.....	3	<b>Care &amp; Cleaning</b> .....	<b>10</b>
Specifications.....	3	<b>Troubleshooting</b> .....	<b>10</b>
Tools Required.....	3	<b>Warranty</b> .....	<b>11</b>
Package Contents.....	4		

# SAFETY INFORMATION

## IMPORTANT

THIS PRODUCT MUST BE INSTALLED IN ACCORDANCE WITH THE APPLICABLE NATIONAL ELECTRICAL CODE AND LOCAL BUILDING CODES BY A PERSON FAMILIAR WITH THE CONSTRUCTION AND OPERATION OF THE PRODUCT AND THE HAZARDS INVOLVED.

## PRECAUTIONS

- Please read and understand this entire manual before attempting to assemble, install, or operate this light fixture.
- This light fixture requires a 120-277 Volt AC power source.
- Some codes require installation by a qualified electrician.
- This light fixture must be properly grounded.
- Make sure connections are secure using wire nuts, crimp-on lugs or other approved connecting devices
- This light fixture should be installed outdoors to a wall or eave.



**WARNING:** Turn the power off at the circuit breaker or fuse. Place tape over the circuit breaker switch and verify power is off at the light fixture.



**WARNING:** Risk of fire. Keep the fixture heads at least 3 in. (76mm) from combustible materials.



**CAUTION:** Burn hazard. Allow the light fixture to cool before touching.



**NOTICE:** Do not connect this fixture to a dimmer switch.



**NOTICE:** FCC Regulations state that any unauthorized changes or modifications to this equipment not expressly approved by the manufacturer could void the user's authorization to operate this equipment.



**INFORMATION:** The device is tested and found to comply with Part 15 of the FCC Rules. Operation is subject to two conditions: (1) This device may not cause harmful interference and, (2) this device must accept any interference received, including any interference that may cause undesired operation.

These limits are designed to provide reasonable protections against harmful interference when the equipment is operated in a commercial environment.

# PRE-INSTALLATION

## PLANNING INSTALLATION

Before installing the light fixture, ensure that all parts are present. Compare parts with the **Hardware Included** and **Package Contents** sections. If any part is missing or damaged, do not attempt to assemble, install, or operate this light fixture.

## SPECIFICATIONS

	PRWX15	PRWX30
<b>Lumens (Light Output)</b>	1500 Lumens	3000 Lumens
<b>Watts (Power Consumption)</b>	15 Watts LED	28 Watts LED
<b>Replaces</b>	100W Incandescent	200W Incandescent
<b>Lumens/Watts (Efficacy)</b>	100 Lumens per watt	107 Lumens per watt
<b>Power Requirements (Input Voltage)</b>	120-277VAC, 50/60 Hz	
<b>Light Color (CCT)</b>	4000 Kelvin	
<b>Dimmable</b>	Non-Dimming (Do not wire to dimming switch)	
<b>Operating Modes</b>	<b>Dusk-to-Dawn:</b> Automatically turns light fixture ON during night and OFF during day.  <b>Switch-Controlled:</b> Flip switch to turn light fixture ON and OFF. Use included light sensor cover on fixture's light sensor to utilize this mode setting.	

## TOOLS REQUIRED



Phillips screwdriver



Wire strippers/cutters



Circuit tester



Silicone sealant



Work gloves



Ladder



Safety goggles

# PRE-INSTALLATION (CONTINUED)

## PACKAGE CONTENTS

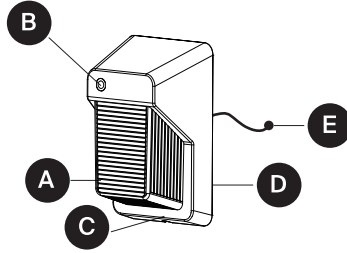

Part	Description	Quantity
A	Light fixture	1
B	Photocell (light sensor)	1
C	Mounting plate tightening bolt (pre-installed)	1
D	Mounting plate with gasket (pre-installed)	1
E	Hanger Wire for hands-free installation (pre-installed)	1

## HARDWARE KIT



**NOTE:** Hardware *not* shown to actual size.

AA



BB

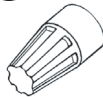

CC



DD



Part	Description	Quantity
AA	#8-32 x 3/4" Phillips head screw	2
BB	Wire nut	3
CC	Hex head screwdriver	1
DD	Photocell black cover label	1

# INSTALLATION

## 1 For best results

- Install light 5-10 feet above the ground.
- Do not mount fixture close to reflective surfaces such as windows, white walls, white surfaces and water.
- Do NOT wire to a dimming switch.



Wall Mount



(fig 1).



**NOTE:** Mounting plate (D) mounts to standard recessed junction boxes. Junction box must be at least 1-1/2 inch in depth for proper installation for recessed mount application (fig 2).

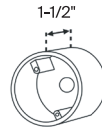

Round

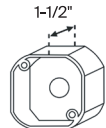

Octagonal

(fig 2).

## 2 SHUT OFF ELECTRIC POWER OFF

- Verify wall switch is in OFF position (fig 3).
- At the main electrical panel, turn off the circuit breaker that supplies power to the junction box you are working on (fig 4).
- For screw-in type fuses, unscrew the fuse that supplies power to the junction box you are working on (fig 5).

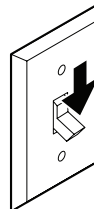

(fig 3).

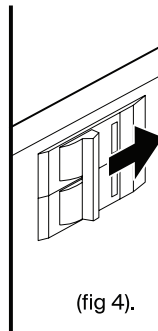

(fig 4).

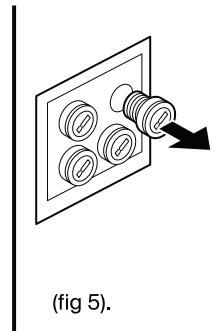

(fig 5).

## INSTALLATION (CONTINUED)

### 3 REMOVE THE MOUNTING PLATE



**NOTE:** The mounting plate (D) comes pre-assembled on the light fixture (A) for shipping.



**NOTE:** The mounting plate tightening bolt (C) come pre-installed on the light fixture.

- Remove the mounting plate (D) from the back of the fixture by loosening the mounting plate tightening screw (C) using the screwdriver (CC).



**TIP:** Only loosen the tightening screw (C) far enough to remove the mounting plate (D). Do not fully remove the tightening screw (C).

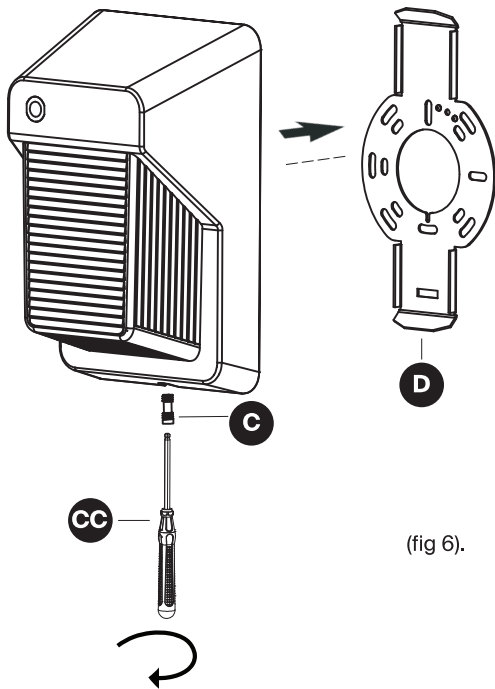

(fig 6).

### 4 INSTALL THE MOUNTING PLATE TO THE JUNCTION BOX

- Route the junction box wires through the large center hole in the mounting plate (D).
- Align the holes on the mounting plate (D) with the holes of the junction box. Use two #8 screws (AA), to attach the mounting plate (D) to the junction box.
- **Please make sure** the "TOP" arrow on the mounting plate is pointing up for wall mount.

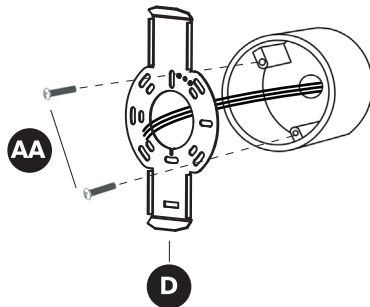

(fig 7).

## INSTALLATION (CONTINUED)

### 5 HANG FIXTURE TO MOUNTING PLATE

- Place the small sphere head of the hanger wire (E) behind the back of the small groove located on the bottom of the center hole of the mounting plate (D). (fig 8).

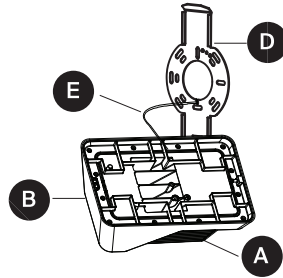
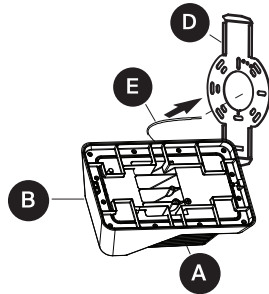

(fig 8).



**TIP:** Ensure the light fixture (A) can safely hang onto the mounting plate (D) to allow for use of two hands to make the wiring (fig 8) connections.

### 6 MAKE THE ELECTRICAL CONNECTIONS

- If necessary, strip 3/8" of insulation from junction box and lighting fixture wires.
- Connect wires by twisting the exposed wires together and using the wire nuts (BB). Ensure no loose wires.
- Connect lighting fixture black wire to junction box black wire (line), lighting fixture white wire to junction box white wire (common), the junction box ground wire to the green lighting fixture ground wire, which is attached to the mounting plate (D) (fig 9).

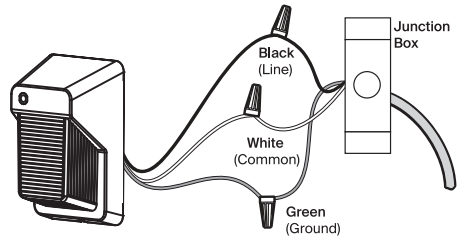
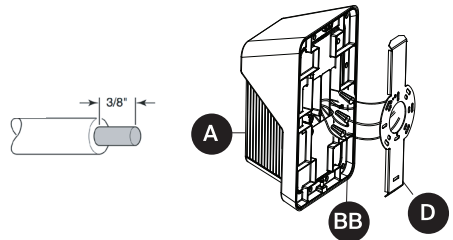

**Wiring Diagram**

Do not wire to a dimming switch.

(fig 9).



**TIP:** Hold stripped ends near each other and align any frayed strands (do not twist wires).

Push the wires into wire nut (BB) and use your fingers to twist the wire nut clockwise until tight. Check for tightness by pulling wires.

## INSTALLATION (CONTINUED)

### 7 MOUNT THE LIGHT FIXTURE

- Once wiring connections are done, place the light fixture (A) onto the mounting plate (D) so the top sloped groove on the plate rests on the top sloped groove on the back of the fixture.
- Verify the fixture is flush with the mounting surface and photocell (B) is pointed forward.
- Tighten the mounting plate tightening screw (C) on the bottom of the fixture (A) until the screw firmly pushes against the mounting plate (D). (fig 10).

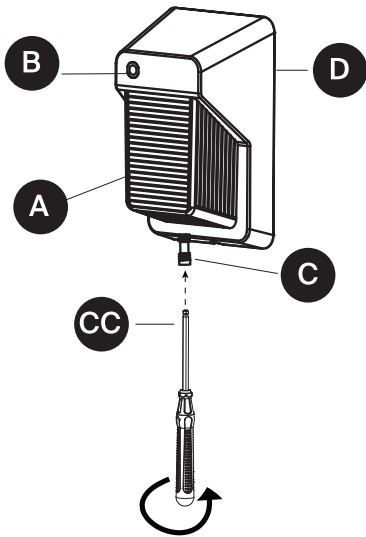

(fig 10).

### 8 CAULK AROUND THE LIGHT FIXTURE

- Caulk around the mounting plate (D) and surface with silicone sealant (not included). (fig 11).

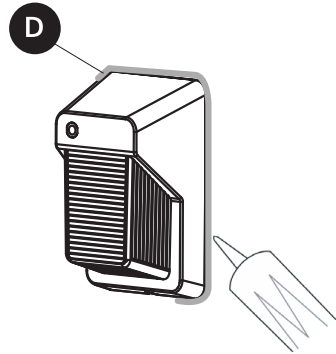

(fig 11).



**NOTICE:** Failure to properly caulk around the surface and mounting plate (D) could lead to water damage and is not covered under warranty.



**NOTE:** When attaching the light fixture (A) to a surface mount junction box, caulk between the mounting plate and junction box.



# OPERATION

## 1 SELECT DUSK-TO-DAWN OR SWITCH-ACTIVATED CONTROL

### OPTION 1: DUSK-TO-DAWN OPERATION

Dusk-to-dawn operation enables the light fixture to automatically turn ON when dark outside and turn OFF when the sun rises, thus saving you energy.

- Ensure the photocell (B) is unobstructed. (fig 12).
- Ensure the switch powering the light fixture/ junction box is turned to the ON position and leave it ON at all times to enable automatic dusk-to-dawn operation.

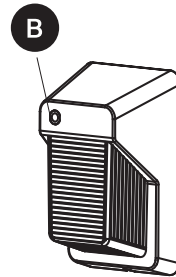



(fig 12).

**AUTOMATIC**  
NIGHTTIME ON



DAYTIME OFF

 **TIP:** To test if the light fixture and photocell work properly, run power to the fixture and cover the photocell to turn fixture ON. Shine a light into the photocell to see if fixture turns OFF.

 **NOTE:** If photocell is located in an area under heavy shade, the photocell may not detect enough light and may turn the light fixture on.

### OPTION 2: SWITCH CONTROLLED

Switch controlled operation enables the light fixture to turn ON and OFF by flipping a switch that controls the electricity to the junction box powering the fixture. The light fixture will not turn ON and OFF automatically, but is manually controlled.

- To enable switch activated operation, paste the black label cover label (DD) over the photocell (B). (fig 13).

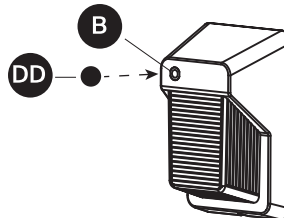

**SWITCH**  
  
**CONTROLLED**

(fig 13).

(To block the photocell, paste the black label cover provided in the kit over the photocell eye)

## CARE AND CLEANING

- Shut off main power supply before cleaning the product. To prolong the original appearance, clean the light fixture with clear water and a soft, damp cloth only.
- Do not use abrasive cleaners or cleaners that contain alcohol. Do not apply paints, solvents, or any other chemicals on this light fixture. They could cause a premature deterioration of the finish and may void the warranty.
- Do not spray the light fixture with a hose or power washer.

## TROUBLESHOOTING

Problem	Possible Cause	Solution
<b>Light does not turn ON</b>	No power to the fixture	Check if circuit breaker is tripped Confirm wall switch is ON Verify wiring to fixture is correct (turn power off to fixture beforehand)
	Fixture is sensing daylight	Cover photocell. Wait several seconds until fixture turns ON.
<b>Light cycles ON and OFF continuously</b>	Photocell light sensor is sensing reflected light	Relocate light fixture to a location where there is no reflected light. OR place the black label cover label over the photocell and use the wall switch to turn the light fixture ON and OFF.
<b>Light stays ON</b>	Photocell is in a shaded area	Shine a flashlight into the photocell and wait a couple minutes. If the light turns OFF, the fixture should be moved to a location with enough light in the daylight hours for the photocell to work. OR place the black label cover label over the photocell and use the wall switch to turn the light ON and OFF.
	Photocell is faulty	If the light does not turn off when a flashlight is shone on the photocell for a few minutes, then the photocell may be faulty. Please contact customer service.



**NOTE:** Photocell may have a few minutes delay during troubleshooting. When testing, shine a light and/or cover the photocell and allow a few minutes for fixture to function properly.

## 5-Year Limited Warranty

---

This is a limited warranty offered by Probrite for a period of five years from the date of purchase to its customers. Probrite warrants to customers that the products will be free from defects in material and workmanship. The obligation of Probrite under this warranty is limited to the provision of replacement of products and is extended to the original purchaser of the product on presenting valid purchase receipt or other proof of date of original purchase acceptable to Probrite. The receipt is required for rendering the warranty performance. Any warranty claims without original proof of purchase would not be accepted.

It should be noted that the warranty does not apply to Probrite products that have been altered or repaired by unauthorized personnel, have been subjected to neglect, abuse, misuse or accident or damages caused during shipping. Any other products not manufactured by Probrite which have been supplied, installed and/or used in conjunction with Probrite products are not covered under this warranty. Any damages caused by replacements bulbs, LEDs or corrosion or discoloration of brass components are also not covered by this warranty.

### **Limitation of Liability:**

In no event Probrite shall be liable for indirect, consequential, incidental or special damages, or lost profits. Probrite is not liable for any claims or damage arising out of or connected with the manufacture, sale, delivery, use, maintenance and repair or modification of Probrite products, or supply of any replacement parts that, exceed the purchase price of Probrite products giving rise to a claim. Labor charges to remove or install the fixtures will not be accepted.

### **To Claim:**

Please contact PROBRITE customer service at 1-844-507-5651 or email [support@probrite.com](mailto:support@probrite.com) and include your name, address and contact number, along with a copy of the purchase receipt and a brief description of the problem.

# PROBRITE®

## **Questions? / Missing Parts? / Need Accessories?**

Before returning to the store, call or email our  
Lighting Specialists 9am-5pm EST Monday to Friday.

**1-844-507-5651**

[support@probrite.com](mailto:support@probrite.com)

[www.probrite.com](http://www.probrite.com)

**RETAIN THIS MANUAL FOR FUTURE USE**

Para las translaciones en español,  
visit [www.probrite.com/install](http://www.probrite.com/install)