

## LEDVANCE Luminaires

### Backlit Dual Selectable Panel with Sensor

PERFORMANCE CLASS

#### Application

LEDVANCE Backlit Dual Selectable Panel with integrated Sensor is a versatile product that offers a quick and easy selection from 3 light colors and 3 maximum lumen output options in the same product. It is the ideal solution for offices, schools, hospitality and commercial applications in general.

#### Benefits and Features

- Integrated daylight/motion microwave sensor
- 3 selectable light colors: 3500K, 4000K and 5000K
- 3 selectable maximum wattage and lumen outputs
- Backlit technology that offers even lighting distribution without shadowing
- DLC Premium listed to maximize rebate opportunities
- Remote control sold as a separate accessory for additional sensor configuration options
- Ready for Emergency Battery Back-up
- Up to 125 LPW
- CRI >80
- Offered in 1x4, 2x2 and 2x4 dimensions
- Energy savings up to 64%

#### Electrical

- 120-277V<sub>AC</sub>
- Power factor >0.9
- THD <20%
- Dimmable

#### Rated Life

- 50,000 hours (L<sub>70</sub>)

#### Warranty

- 5-year
- NLB Trusted Warranty Program

#### Ambient Operating Range

- -4°F to +113°F (-20°C to +45°C)

#### Factory Settings

- 4000K
- Highest wattage



#### Certifications and Listings

- cULus
- RoHS
- FCC
- DLC Premium

#### Installation

- Recessed, surface or suspended mounting



## Specification Data

Catalog #	Type
Project	
Comments	
Prepared by	

## Ordering Guide

PANELF	4B	S	XXX	D	8	SC7	XX	G	WH	M
Product Name	Generation	Selectable Wattage	Voltage	Dimming	CRI	Color Temp (CCT)	Dimensions	Mounting	Color/Finish	Options
PANELF =	4B	030 = max. 30 Watts	UNV = 120-277V	D = 0-10V	8 = >80	SC7 = 3500K, 4000K and 5000K	14 = 1x4 22 = 2x2 24 = 2x4	G = Grid	WH = White	M = Sensor
LED Panel		045 = max. 45 Watts 055 = max. 55 Watts								

## Ordering Information

Item Number	Ordering Abbreviation	Power (W)	Input Voltage	Dimming	CRI	Color Temp (CCT)	Total Lumens	DLC	Options
62255	PANELF4BS030UNVD8SC714GWHM	20/25/30W	120-277V	DIP Switch or Remote	80	3500K, 4000K, 5000K	2500/3125/3750	Premium	Motion/Daylight Sensor
62256	PANELF4BS045UNVD8SC722GWHM	36/40/45W	120-277V	DIP Switch or Remote	80	3500K, 4000K, 5000K	4500/5000/5625	Premium	Motion/Daylight Sensor
62257	PANELF4BS055UNVD8SC724GWHM	40/50/55W	120-277V	DIP Switch or Remote	80	3500K, 4000K, 5000K	5000/6250/6875	Premium	Motion/Daylight Sensor

## Physical Information

Lamp Description	(A) Length in (mm)	(B) Width in (mm)	(C) Height in (mm)
1x4	47.7 (1212)	11.9 (302)	1.4 (35)
2x2	23.7 (603)	23.7 (603)	1.4 (35)
2x4	47.7 (1212)	23.7 (603)	1.4 (35)

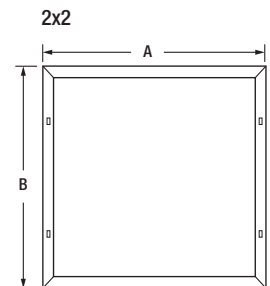
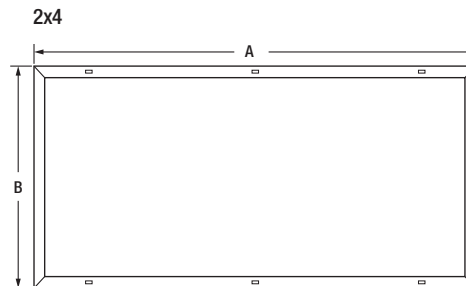
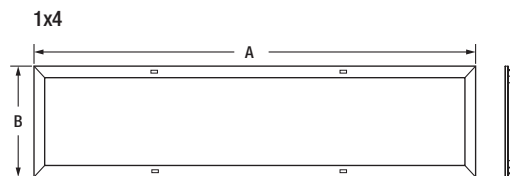

## Accessories and Replacement Parts

Item Number	Ordering Abbreviation	Item Description
60888	EMBB1A8WDC	Field installable emergency battery back-up unit
61682	ACCPANELF3AEMBB-BRIDGE2	Metal bridge for installing emergency battery back-up unit to 2x2 and 2x4 panels
61683	ACCPANELF3AEMBB-BRIDGE1	Metal bridge for installing emergency battery back-up unit to 1x4 panels
<b>Mounting Accessories</b>		
62064	SMKIT3A/22/WH	Surface Mounting Kit for 2x2 Backlit Panel, extruded aluminum, white finish
62065	SMKIT3A/24/WH	Surface Mounting Kit for 2x4 Backlit Panel, extruded aluminum, white finish
62066	SMKIT3A/14/WH	Surface Mounting Kit for 1x4 Backlit Panel, extruded aluminum, white finish
62067	SPKIT3A	Suspension Mounting Kit for Backlit Panel
60457	FK1A14GWH	Flange Kit 1' x 4'
60458	FK1A22GWH	Flange Kit 2' x 2'
60459	FK1A24GWH	Flange Kit 2' x 4'
<b>Remote Control</b>		
60105	HIBAY2A/REMOTE	Remote Control for additional configuration options

### Surface Mount Kit

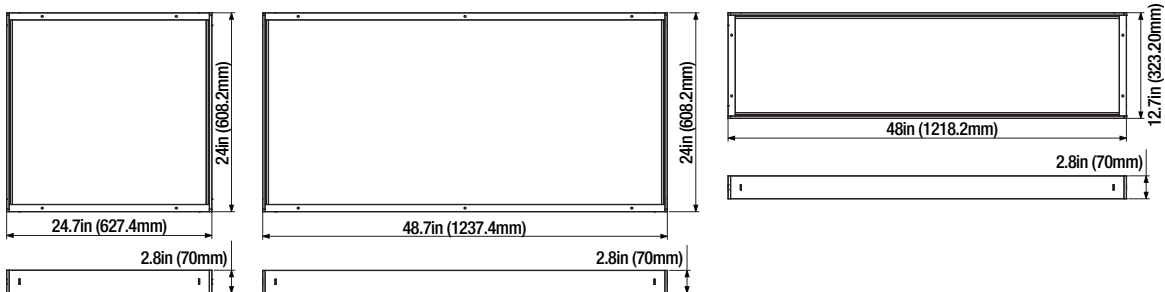

### Flange Kit

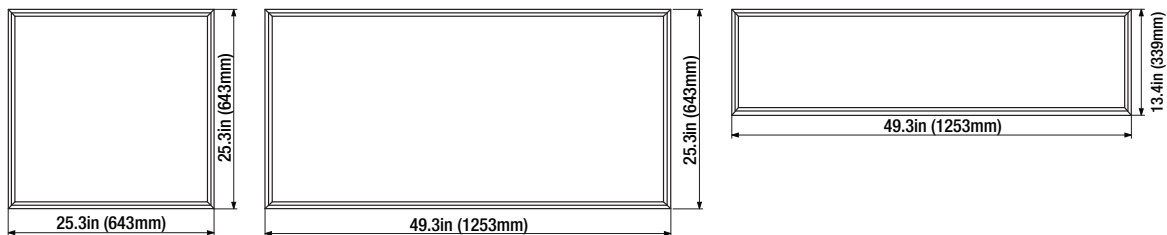

## Options Information

### Emergency Battery Backup

Emergency Battery Backup: Activates when normal power supply to the fixture fails, providing a minimum of 790 lumens (850 nominal lumens) for at least 90 minutes.

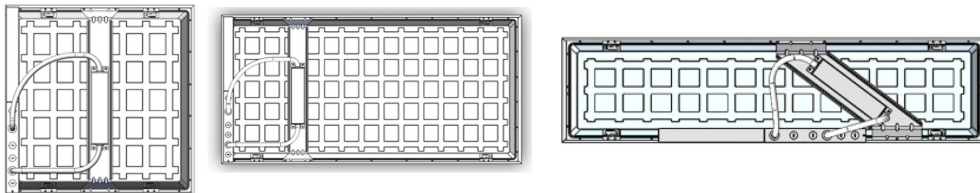

### Location of Emergency Test Switch

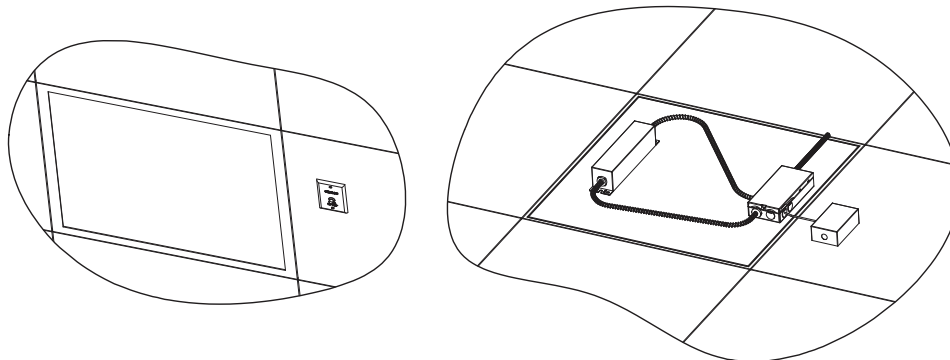

## Sensor DIP Switch Settings

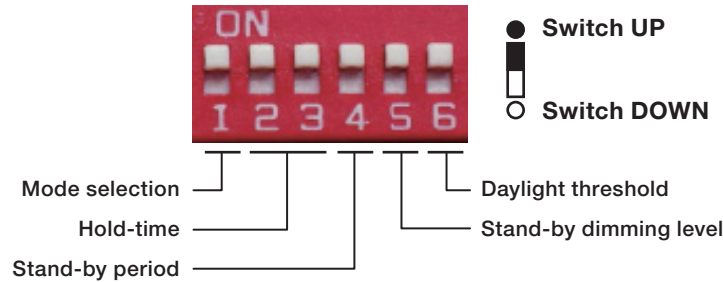

1	
●	OFF
○	ON 100%

### Mode selection

DIP switch up to "OFF", it will change to Power Mode without sensor function; DIP switch down to "ON", it will change to Sensor Mode; default detection area is 100%.

2	3	
●	●	30s
●	○	1min
○	●	5min
○	○	3min

### Hold-time

The period of light keeping 100% brightness after moving objects leave the detection area.

4	
●	+∞
○	1min

### Stand-by period

The period of light keeping low output before it's completely switched off. When it's preset as "∞", the light always keep at low output if no movement in the detection area and doesn't turn off.

5	
●	30%
○	10%

### Stand-by dimming level

The definition of low output in the standby period.

6	
●	ON 50LUX
○	OFF

### Daylight threshold

DIP switch up to "ON", enable daylight function; default daylight threshold is 50Lux.

DIP switch down to "OFF" for daylight disable.

## Remote Control Configuration Instructions

**Start:** Press to customize scene. Users can change detection range, daylight threshold, holdtime, standby dimming level and standby period.

**Memory:** Press to save all the settings. Settings remain from last time used if not reset.

**Apply:** Activates the saved setting.

Pressing "Apply" without "Memory" will make all the settings one-time operation.

Settings should be done within 30s, otherwise it exits memory mode.

**Detection area** (Press to define detection area: 100%/75%/50%/25%).

**Hold time** (Press to define hold time: 5s/30s/1min/2min/5min/10min/20min/30min).

**Daylight threshold** (Press to define daylight level 2Lux/10Lux/30Lux/50Lux/80Lux/120Lux/Disable).

Note: Disable means light will be turned on once sensor detects movement, regardless of the ambient lux.

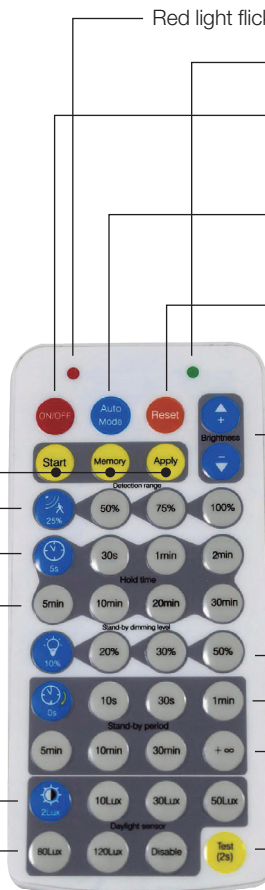

Red light flickers after pressing any button

Green light flickers only after pressing "Apply" button

**ON/OFF:** only functions as an on/off switch for the light. If button is pressed to turn off the lamp before it's short-circuited, the lamp will remain off after next power-on.

**Auto Mode:** Enables sensor; all settings remain the same before the light gets switched on/off.

**Reset:** Press to change brightness to max level. Products with DIP switch will be controlled by DIP switches; otherwise all the settings will be as initialized, that is, 100% detection range, hold time 5s, no stand-by time and daylight threshold disabled.

**+/-:**  
1. Adjusts brightness 10-100% in on/off mode.  
2. Adjusts highest brightness 60-100% in sensor mode.

**Stand-by dimming level** (Press to define stand-by dimming level: 10%/20%/30%/50%).

**Stand-by period** (Press to define stand-by period: 0s/10s/30s/1min/5min/10min/30min/+∞).

Note: "0s" means no standby period; "+∞" means unlimited standby period

**Test (2s):** For testing purpose after commissioning. Pressing this button puts the sensor in test mode (hold time is only 2s).

## Remote Control Configuration Instructions (continued)

### Memory & Apply Mode

1. Press "ON/OFF" button to turn on the light or off.
  2. To reset the parameters, please follow the steps below:
    - Step 1 – Press "ON" to turn on the light if it was off at the start.
    - Step 2 – Press "Start" to set the sensor.
    - Step 3 – Press Detection range, Hold time, Stand-by dimming level, Stand-by period and Daylight threshold one after the other in sequence.
    - Step 4 – Press "Memory" to memorize the settings.
- Note: The interval of each parameter setting shall be controlled within 30s.
3. To program other lights in the array that have similar sensors to the same program:
    - Step 1 – Press "ON" to the second sensor
    - Step 2 – Press "Apply"

### Isolated Setting Mode

1. Press "ON/OFF" to turn on the light or off. Press "Auto Mode", the remote will activate settings that were saved last or remain at the factory default settings.
2. To reset the parameters, Please follow the steps as below:
  - Step 1 – Press ON, to turn on the light if it was off at the start.
  - Step 2 – Press any of the following: "Auto Mode", "Reset", "Test" or "Apply" to enter sensor detection mode.
  - Step 3 – Press Detection range, Hold time, Stand-by dimming level, Stand-by period and Daylight threshold one after the other in sequence.

### Notes:

1. Settings will be saved automatically and remain until you press reset again.
2. Light will flicker when setting each parameter.

LEDVANCE LLC  
200 Ballardvale Street  
Wilmington, MA 01887 USA  
Phone 1-800-LIGHTBULB (1-800-544-4828)  
[www.ledvanceUS.com](http://www.ledvanceUS.com)

SYLVANIA and LEDVANCE are registered trademarks.  
All other trademarks are those of their respective owners.  
Licensee of product trademark SYLVANIA in general lighting.  
Specifications subject to change without notice.

 /sylvania  /sylvania

